

# SKB 108-960 MAG

VHF Mobile Antenna 108...960 MHz Stainless steel whip

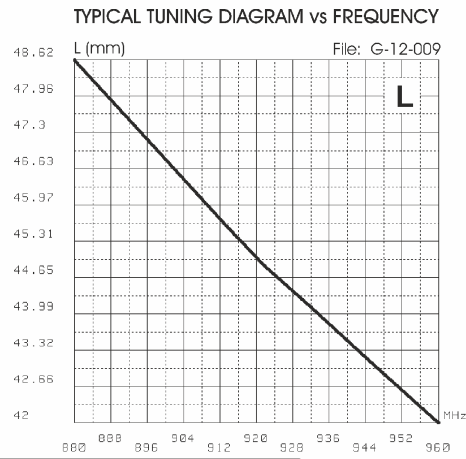

## MATCHING & BANDWIDTH DIAGRAMS

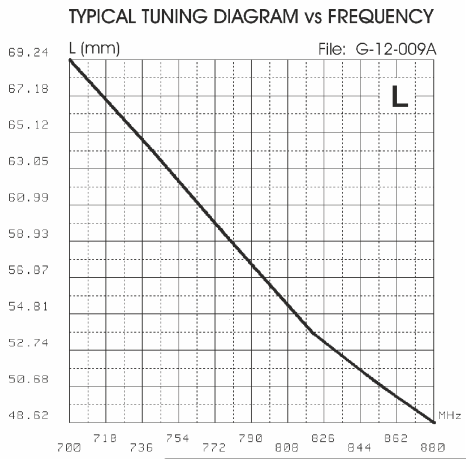
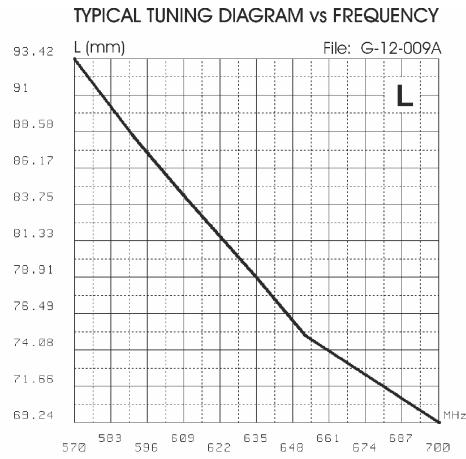
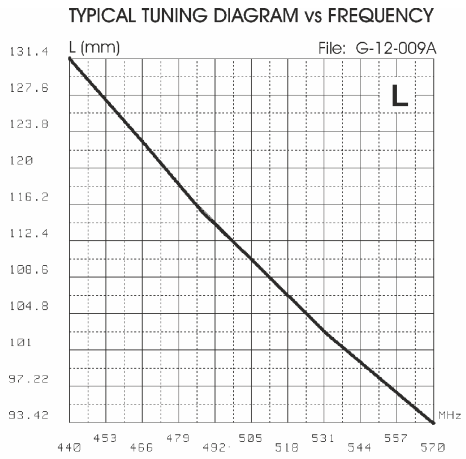
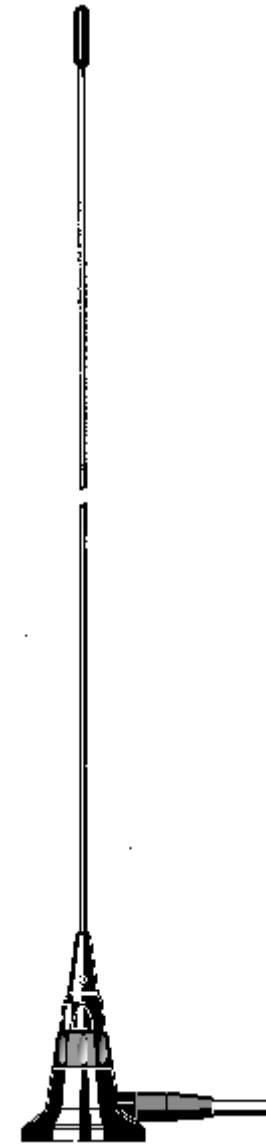
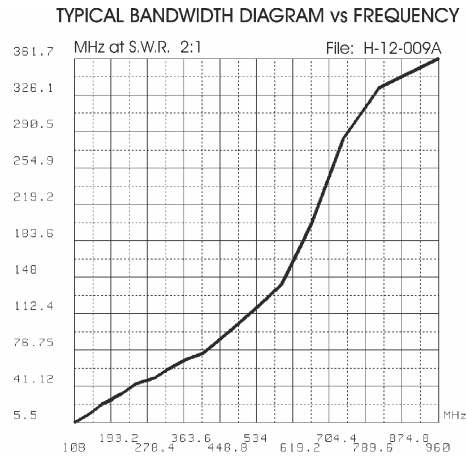
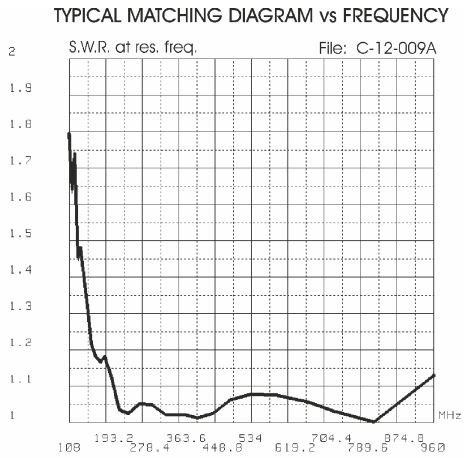

## Installation Manual

## DESCRIPTION

1/4  $\lambda$  mobile antenna covering the frequency range of 108...960 MHz by using the enclosed cutting diagram. It is made of 17/7 PH stainless steel and supplied with "CELL MAG", the small magnet mount for temporary installation on the vehicle.

## SPECIFICATIONS

### Electrical Data

Type	: 1/4 $\lambda$
Frequency Range	: from 108 to 960 MHz tunable by cutting
Impedance	: 50 $\Omega$
Radiation	: Omnidirectional
Polarization	: Vertical
Gain	: 0 dB ref. to a $\lambda/4$ whip
Bandwidth @ SWR $\leq$ 2	: see diagram
SWR @ res. freq.	: see diagram
Max Power	: 100 Watts for 108...550 MHz; 30 Watts for 550...960 MHz
Feed System / Position	: Direct / Base
Standard Mount	: "CELL MAG", magnetic mount, cable 3m RG 58, FME-female

### Mechanical Data

Materials	: Stainless steel 17/7 PH, Chromed Brass, Nylon
Height (approx.)	: 700 mm
Weight (approx.)	: 315 gr

## MOUNT DIMENSIONS

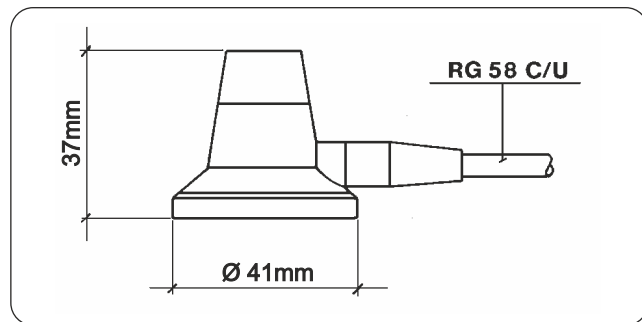

## TUNING INSTRUCTIONS

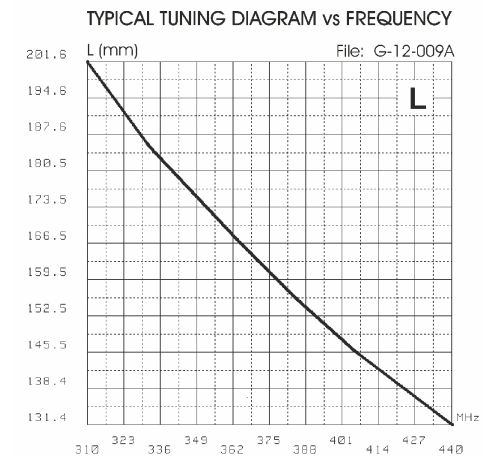
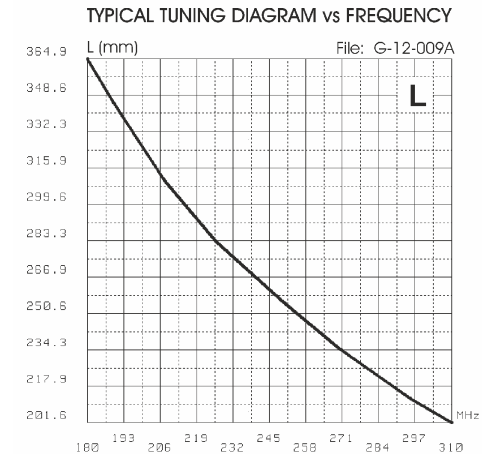
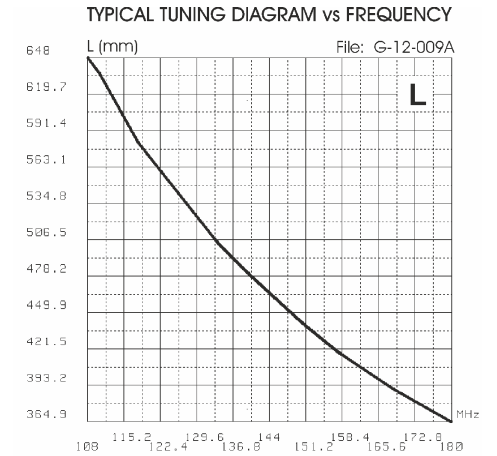
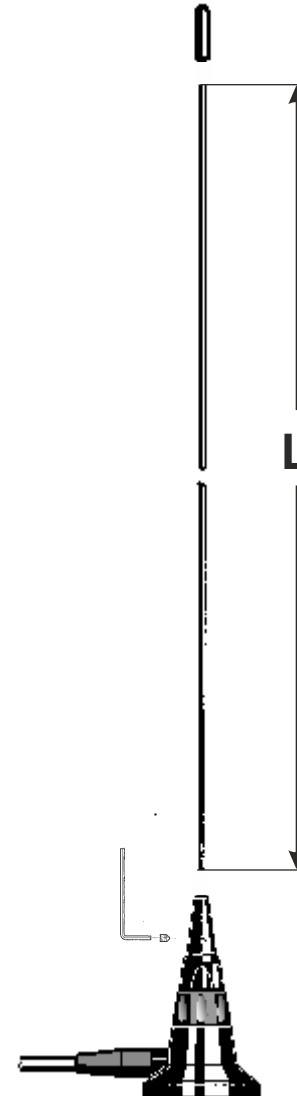

### NOTE:

- Use the curves just as a guide. For fine-tuning please use an SWR-Meter.



**SIRIO**  
antenne

HI-QUALITY ANTENNAS MADE IN ITALY